

IP  
44

RAL

LED



CE



# Ceramic

Ceramic LED emergency is a surface and recess-mounted emergency light for open areas. Model is suitable for areas with 2-8 meter's height. Has a elegant design with a aluminium body, RALcolours available upon request. Suitable for demandig environments.

Light source ..... LED  
 Light temperature..... 5100K / 4000K / 3000K  
 Lens..... Flood- / Spotlight  
 IP class..... IP20 or IP44  
 Supply voltage model A12 - 42 V AC / 12 - 60 V DC  
 Supply voltage model B..... 230 V AC/DC  
 Supply voltage model C- and C/AT..... 230 V AC  
 Protection class model A..... III  
 Protection class model B and C/AT ..... I  
 Input power model A ..... < 5 W  
 Input power model B and C/AT..... < 5 W / & VA  
 Temperature range..... -30...+50°C  
 -battery models ..... -10...+40°C  
 Battery / Backup time ..... Ni-MH 6V / 3 h  
 Body material..... Aluminium / Polycarbonate  
 Cover  
 . White powder coated or sandblasted aluminium  
 Mounting options..... Surface, recessed  
 Country of origin ..... Finland  
 Warranty..... 2 years  
 Standards..... EN 60598-2-22, EN 1838

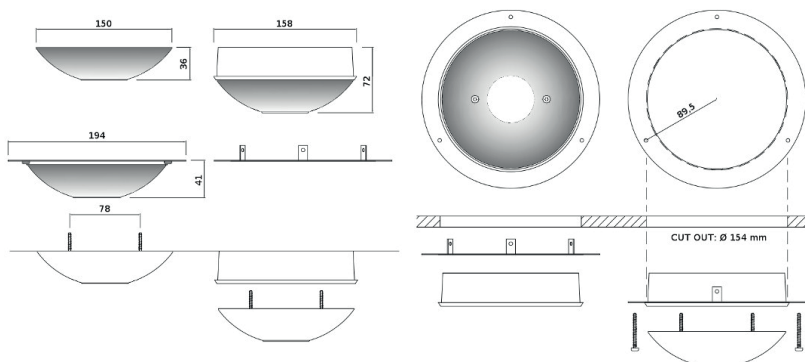

Light distribution, flood  
Height 2,5 m

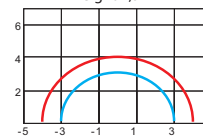

Light distribution, spot  
Height 2,5 m

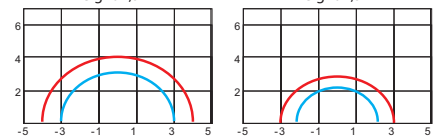

Height 3 m

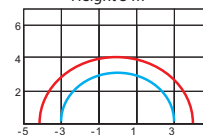

Height 4 m

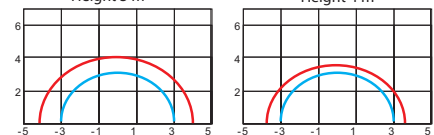

Height 4 m

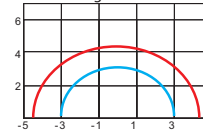

Height 8 m

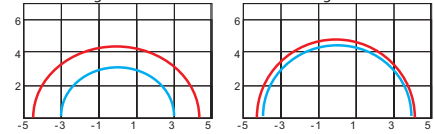

— = 0,5 lux  
 — = 1 lux



WIKROLUX

Oy Wikrolux Ab, Penviikintie 10, FI68600 Pietarsaari  
 Tel. +358 (0)6 723 4567, info@wikrolux.fi

## CERAMIC A

Product code	Name	Supply voltage		Electrical code (STK)
1700117	CERAMIC A	24V AC/DC	3000K Flood Sandblast	4214347
1700017	CERAMIC A	24V AC/DC	3000K Flood White	4214337
1700142	CERAMIC A	24V AC/DC	3000K Spot Sandblast	4214352
1700042	CERAMIC A	24V AC/DC	3000K Spot White	4214342
1700115	CERAMIC A	24V AC/DC	4000K Flood Sandblast	4214221
1700015	CERAMIC A	24V AC/DC	4000K Flood White	4214201
1700140	CERAMIC A	24V AC/DC	4000K Spot Sandblast	4214226
1700040	CERAMIC A	24V AC/DC	4000K Spot White	4214206
1700165	CERAMIC A	24V AC/DC	5100K Flood Sandblast	4214231
1700065	CERAMIC A	24V AC/DC	5100K Flood White	4214211
1700190	CERAMIC A	24V AC/DC	5100K Spot Sandblast	4214236
1700090	CERAMIC A	24V AC/DC	5100K Spot White	4214216

## CERAMIC B

Product code	Name	Supply voltage		Electrical code (STK)
1700417	CERAMIC B	230V AC/DC	3000K Flood Sandblast	4214377
1700317	CERAMIC B	230V AC/DC	3000K Flood White	4214367
1700442	CERAMIC B	230V AC/DC	3000K Spot Sandblast	4214382
1700342	CERAMIC B	230V AC/DC	3000K Spot White	4214372
1700415	CERAMIC B	230V AC/DC	4000K Flood Sandblast	4214281
1700315	CERAMIC B	230V AC/DC	4000K Flood White	4214261
1700440	CERAMIC B	230V AC/DC	4000K Spot Sandblast	4214286
1700340	CERAMIC B	230V AC/DC	4000K Spot White	4214266
1700465	CERAMIC B	230V AC/DC	5100K Flood Sandblast	4214291
1700365	CERAMIC B	230V AC/DC	5100K Flood White	4214271
1700490	CERAMIC B	230V AC/DC	5100K Spot Sandblast	4214296
1700390	CERAMIC B	230V AC/DC	5100K Spot White	4214276

## CERAMIC C/AT

Product code	Name	Supply voltage		Electrical code (STK)
1700632	CERAMIC C/AT	230V AC	3000K Flood Sandblast	4214102
1700612	CERAMIC C/AT	230V AC	3000K Flood White	4214100
1700637	CERAMIC C/AT	230V AC	3000K Spot Sandblast	4214103
1700617	CERAMIC C/AT	230V AC	3000K Spot White	4214101
1700630	CERAMIC C/AT	230V AC	4000K Flood Sandblast	4214324
1700610	CERAMIC C/AT	230V AC	4000K Flood White	4214320
1700635	CERAMIC C/AT	230V AC	4000K Spot Sandblast	4214325
1700615	CERAMIC C/AT	230V AC	4000K Spot White	4214321
1700640	CERAMIC C/AT	230V AC	5100K Flood Sandblast	4214326
1700620	CERAMIC C/AT	230V AC	5100K Flood White	4214322
1700645	CERAMIC C/AT	230V AC	5100K Spot Sandblast	4214327
1700625	CERAMIC C/AT	230V AC	5100K Spot White	4214323

## CERAMIC CG-S

Product code	Name	Supply voltage	
1000064	CERAMIC B CG-S	5100K Flood Sandblast	230V AC/DC
1000065	CERAMIC B CG-S	5100K Flood White	230V AC/DC
1000066	CERAMIC B CG-S	5100K Spot Sandblast	230V AC/DC
1000067	CERAMIC B CG-S	5100K Spot White	230V AC/DC

## CERAMIC CG-S Ready

Product code	Name	
1000068	CERAMIC CG-S Ready	5100K Flood Sandblast
1000078	CERAMIC CG-S Ready	5100K Flood White
1000069	CERAMIC CG-S Ready	5100K Spot Sandblast
1000079	CERAMIC CG-S Ready	5100K Spot White

## CERAMIC DALI

Product code	Name	Supply voltage	
1700678	CERAMIC B DALI	230V AC/DC	5100K Flood Sandblast
1700671	CERAMIC B DALI	230V AC/DC	5100K Flood White
1700672	CERAMIC B DALI	230V AC/DC	5100K Spot Sandblast
1700673	CERAMIC B DALI	230V AC/DC	5100K Spot White
1700674	CERAMIC C/AT DALI	230V AC	5100K Flood Sandblast
1700675	CERAMIC C/AT DALI	230V AC	5100K Flood White
1700676	CERAMIC C/AT DALI	230V AC	5100K Spot Sandblast
1700677	CERAMIC C/AT DALI	230V AC	5100K Spot White

